



JM410 ID Tag Printer **Service Manual**

This manual is intended for qualified service technicians only.



Revision C4
April 2017

INFOSIGHT CORPORATION

20700 U.S. Highway 23

P.O. Box 5000

Chillicothe, Ohio 45601 USA

+1 (740) 642-3600 Tel. (M-F 8am-5pm US Eastern Time Zone)

+1 (740) 642-4666 Emergency Service (outside normal business hours)

+1 (800) 401-0714 Emergency Service Toll Free (US & Canada)

+1 (740) 642-5001 Fax

www.infosight.com

This page intentionally left blank.

COPYRIGHT

Copyright © 2009-2016 INFOSIGHT CORPORATION
All rights reserved. Printed in U.S.A.

First Printing: June 2009

INFOSIGHT CORPORATION reserves the right to make changes in specifications and other information contained in this manual without prior notice, and the reader should consult INFOSIGHT CORPORATION to determine whether any such changes have been made.

In no event shall INFOSIGHT CORPORATION be liable for any incidental, indirect, special, or consequential damages whatsoever (including but not limited to lost profits) arising out of, or relating to this manual or the information contained in it, even if INFOSIGHT CORPORATION has been advised, knew, or should have known of the possibility of such damages.

INFOSIGHT CORPORATION expressly warrants the equipment manufactured by it as set forth in the Standard Terms and Conditions of Sale. INFOSIGHT CORPORATION makes no other warranties, either expressed or implied (including without limitation warranties as to merchant ability or fitness for a particular purpose).

InfoTag®, Labelase®, PermaLabel®, Pic-Anneal®, and Kettle Tag® Plus are registered trademarks of InfoSight Corporation.

Labelase® Producerr™, Info-Tint™, Foam Tag™, Tough Tag™, AlumaTag™, and X-Tag™ are trademarks of InfoSight Corporation.



Windows® is a registered trademark of Microsoft Corporation.

SOFTWARE/FIRMWARE LICENSE AGREEMENT





IMPORTANT: THE SUBJECT PROGRAMS ARE LICENSED BY INFOSIGHT CORPORATION TO END-USERS FOR THEIR USE ONLY ON THE TERMS BELOW. ACCEPTING AND USING THESE PROGRAMS INDICATES YOUR ACCEPTANCE OF THESE TERMS. THIS IS A LEGAL AGREEMENT BETWEEN YOU, THE END USER, AND INFOSIGHT CORPORATION.

- 1) GRANT OF LICENSE. INFOSIGHT CORPORATION ("INFOSIGHT") agrees to grant to you a non-exclusive license to use the INFOSIGHT software/firmware program (the "PROGRAM") subject to the terms and conditions of this license agreement.
- 2) DEFINITION OF TERMS. The term SOFTWARE refers to a computer program stored on CDROM, floppy diskette, hard disk, magnetic tape, paper tape or other media that must be loaded into the computer's memory to be executed. The term FIRMWARE refers to a computer program stored in semiconductor memory (ROM, PROM, EPROM, EEPROM, NVRAM, etc.) that is an integral part of the computer's memory. Together, these forms of computer programs are referred to as the "PROGRAM".
- 3) COPYRIGHT. The PROGRAM(s) and Documentation are owned by INFOSIGHT and are protected by United States copyright laws and international treaty provisions. The PROGRAM(s) contain trade secrets and proprietary property of INFOSIGHT. You may make one copy of the PROGRAM(s) solely for backup or archival purposes provided that the copy clearly displays the INFOSIGHT copyright notice. Additional copies may be made when authorized to do so in writing by INFOSIGHT. In addition to any other right of INFOSIGHT, INFOSIGHT has the right to terminate this license if the terms of this license are violated.
- 4) RESTRICTION ON USE AND TRANSFER. The single-processor version(s) of the PROGRAM(s) and Documentation are to be used on one computer or embedded system at any one time. The multi-processor version(s) of the PROGRAM(s) and Documentation may be used over a network provided that the number of computers accessing the network simultaneously shall not exceed the number authorized by INFOSIGHT or for which you paid the corresponding multi-processor fee. You may not distribute the PROGRAM(s) or Documentation to a third party. You may transfer the license and complete package (retaining nothing) if the transferee agrees to the terms of this License Agreement. Neither the PROGRAM(s) nor the Documentation may be changed or translated without express written permission of INFOSIGHT. You may not reverse engineer, decompile or disassemble the PROGRAM(s).
- 5) WARRANTY for the subject PROGRAM(s) is covered under the INFOSIGHT STANDARD TERMS AND CONDITIONS OF SALE.
- 6) TERM. The license is effective until terminated. It may be terminated if you fail to comply with any term or condition of this License Agreement. You may terminate this License Agreement at any time. In the event of termination, you agree to destroy the PROGRAM(s) and Documentation together with all copies and related material.
- 7) YOUR USE OF THIS PROGRAM(S) acknowledges that you have read this License Agreement and agree to its terms. This agreement is complete and supersedes any other agreement that may have related to the subject matter of this agreement.

Optical/Laser Safety

	<p>INVISIBLE LASER RADIATION AVOID EYE OR SKIN EXPOSURE TO <u>DIRECT OR SCATTERED RADIATION</u> CLASS 1 LASER PRODUCT, USING A CLASS 4 EMBEDDED LASER (10 W, 10.57 – 10.63 μm) <i>The laser beam Exits the Final lens 10 inches above the tag</i></p>
	<p><i>Never attempt to operate the Laser Tag Marker without the protective covers in place. Never attempt to override any of the safety interlocks on the tag printer. Never attempt to dismantle or repair the tag printer. In case of malfunction contact an Infosight service representative. Any of the actions mentioned above may result in permanent eye or skin damage. Refer to Appendix A for more information on laser safety.</i></p>

Symbol Definitions

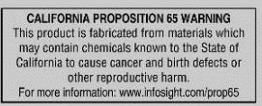
	<p>Caution, Laser Radiation - Consult Accompanying Documents</p>
	<p>Warning label located on top of the main cover: CLASS 4 INVISIBLE LASER RADIATION WHEN OPEN AND INTERLOCKS DEFEATED AVOID EYE OR SKIN EXPOSURE TO DIRECT OR SCATTERED RADIATION</p>
	<p>Caution, Consult Accompanying Documents</p>
	<p>Warning label located above the rating plate on the back of the Laser Marker CLASS 1 LASER PRODUCT</p>
	<p>Warning label located above the rating plate on the back of the Laser Marker: CLASS 1 LASER PRODUCT</p>
<p>Environmental Conditions</p>	<p>The Labelase® Printer is intended for Indoor use only. Altitude up to 6500 feet, operating temperature 40 to 100 degrees F, 80% maximum relative humidity, rated 100-240Vac 50/60 HZ, 2.4 Amps, pollution degree 2</p>
<p>CAUTION</p>	<p>If this printer is not used in the manner specified by this manual, the safety features provided may be insufficient.</p>
	<p>Warning Label located on the back panel of the printer, regarding California Proposition 65.</p>

PREFACE

The JM410 is based on the proven third-generation LabeLase® laser printer architecture, with advanced design features for the printing of single or multiple die-cut tags. The JM410 utilizes the same PC-based Producer™ interface as all LabeLase® printers, and features a larger 4" x 4" (100mm x 100 mm) print area.

This OPERATIONS manual is intended as a companion to the ONLINE REFERENCE MANUALS supplied with the Producer & Designer software package and also available on the Infosight webpage:
<http://www.infosight.com/labelaseproducer2/> .

This OPERATIONS AND MAINTENANCE manual will be automatically installed on your computer hard drive when installing Producer™ software. It may be found under the PROGRAMS menu with other INFOSIGHT software and HELP files.

MINIMUM SYSTEM REQUIREMENTS

- IBM PC 100% compatible computer.
- Windows 7 (32/64bit) / Windows 8/8.1 (32/64 bit) / Windows 10 (32/64 bit)
- 1 Serial Com port, USB port, or Ethernet port (for connection to the printer).
- Color monitor (1024X768 resolution or higher recommended).

TABLE OF CONTENTS

PRINTER SETUP	1
SOFTWARE INSTALLATION	1
SYSTEM CONNECTIONS & POWER-UP:	2
PRINTER COMMUNICATIONS	2
STARTUP SEQUENCE:	3
LOADING TAGS	4
PRINTING A TAG	5
LABELASE® PRODUCER™ SOFTWARE	6
PRINTER CONFIGURATION & LASER SETTINGS	7
CYCLE TIME CONSIDERATIONS	8
USING AN EXHAUST EXTRACTOR	9
BASIC TROUBLE SHOOTING	9
NORMAL MAINTENANCE & SERVICING	11
LENS CLEANING PROCEDURE	11
FUSE REPLACEMENT	13
CUSTOMER SERVICE	14
FUNCTIONAL BLOCK DIAGRAM	15
WIRING DIAGRAM	16
LASER SAFETY	18
Declaration of Conformity	19
APPENDIX A LASER SAFETY	21

This page intentionally left blank.

PRINTER SETUP

The JM410 ID Tag Printer requires 100-240 VAC, 50/60 Hz, 2.4 A. Fused at 5 Amps.

The JM410 ID Tag Printer should be positioned so that the power supply cord exits from the back of the machine. Always leave access to the E-STOP (Emergency Stop Push Button) and power switch that are located on the rear of the machine.

The JM410 ID Tag Printer should be placed in a temperature controlled environment. This printer, though designed for industrial use, should be treated as any typical computer system and printer. Dirty environments will necessitate a more frequent cleaning schedule for internal optics.

A 12-foot (3.6 meter) RS-232 serial communications cable is provided for communicating with your Windows-based PC.

A 15-foot (4.6 meter) USB cable is supplied for USB/Ethernet connectivity.

SOFTWARE INSTALLATION

Before connecting the printer to your PC, LabeLase® Producer™ Software and communications should first be installed on your PC.

The easiest way to install the software is to use the Installer Thumb Drive that came with your new printer. In addition to installing the correct version of Producer™ and Designer for your specific printer model, it will also allow you to configure the appropriate communications interface.

If your original Installer Thumb Drive is not available, OR for the latest release of Producer™ and Designer software, downloaded the installer package directly from <http://www.infosight.com/support/software/37-labelase-producer-metal-tag-production-software>. This is a self-contained, single self-installing file. However, it will not automatically guide you through the configuration process for communications, and you must therefore follow the steps outlined in the LabeLase® Producer™ Software Installation Manual.

The LabeLase® Producer™ Software Installation Manual is available and shipped with your equipment. The Installation Manual covers printer connection, communication connections, and installation of the software. Refer to this manual for any issues during software installation on your PC.

NOTE: LabeLase® Producer™ and Designer Software are separate executable programs, however they are bundled together and downloaded/installed together.

SYSTEM CONNECTIONS & POWER-UP:



USB & Ethernet ports exist under the RS 232 port (1, above). Refer to the Communications Section of this manual for instructions on installing the required drivers.

1. Attach the included RS-232 cable, USB, or Ethernet cable from the JM410 ID Tag Printer to your Windows-based PC running LabeLase® Producer™ software.
2. Insert the AC power cord into a nearby power receptacle. **Note: Both sides of the incoming line voltage are fused. See the Maintenance section of instructions on replacing fuses.**
3. Place the security key into rear of machine, near the power cord exit point. The key functions as an ON-OFF switch.
4. Turn the key to the horizontal (I) (ON) position. NOTE: The security key can only be removed when in the vertical (O) (OFF) position.
5. Press the power switch to the ON (I) position. The power switch is located directly above the power cord.
6. Disengage the E-Stop by twisting the red button one-quarter turn clockwise.

PRINTER COMMUNICATIONS

The JM410 requires a communication link to a PC running Producer™ software. In addition to the serial RS232 link, an integrated USB/Ethernet module is provided. The LabeLase® Producer™ Software Installation Manual addresses Printer Communications in Sections “Connection Type”, “RS232 Serial COM Port”, “USB Port”, and “Ethernet Network Connection”.

STARTUP SEQUENCE:

1. Confirm that the rear power switch is on (I) and the rear key switch is in the horizontal (I) ON position.
2. Disengage E-STOP by twisting the red button one-quarter turn clockwise.
3. The drawer will open automatically when the E-STOP is disengaged and the power is on. Place desired tag(s) in the drawer.
4. Start LabelLase® Producer™ software on your PC.
5. Load a pre-existing tag layout, or design a new tag layout. NOTE: designing or changing a tag layout requires SUPERVISOR login.
6. Adjust printer setup parameters if necessary (e.g., laser speed). NOTE: other than setting laser speed (LIGHTER/DARKER slider bar), this feature requires SUPERVISOR login.



NOTE: The printer should generally be turned on before starting Producer™. This will allow Producer™ to poll the printer for its configuration parameters and load them into Producer's™ working memory.

If Producer™ is already running when the printer is turned on, Producer™ will force-download whatever parameters were last used when Producer™ was controlling a printer. This can cause unexpected results if the previous printer was a different model, or if its setup was modified for a special application.

Remember – PRINTER ON FIRST!!

USB & Ethernet ports exist under the RS 232 port (1, above). Refer to the Communications Section of this manual for instructions on installing the required drivers.

NOTE: The Producer™ software is password protected for all features beyond loading an existing tag layout, entering tag variable data, adjusting laser speed and initiating printing.

The default password for new installations is blank (no data, no spaces). A new password should be created before printer is commissioned for regular operator use.

Reminder - The marker is not ready for use and will not feed tags until the E-STOP button is returned to the OUT position by twisting the red button one-quarter turn **CLOCKWISE**.

LOADING TAGS

Use only InfoSight tags in the JM410 Printer. When the JM410 ID Tag Printer is on but not printing, the tag drawer will open automatically. Single tags up to 4" x 4" (100mm x 100mm) or multiple smaller tags may be loaded into the drawer.

Loading a Single Tag

1. Ensure the Tag Drawer is open.
2. Place desired tag into the drawer, aligning the top left corner of the tag to the top left corner of the drawer.
3. The drawer is magnetized so any magnetic tags will hold themselves in place. When printing non-magnetic tags that are smaller than 4" x 4" (100mm x 100mm), a magnetic tag shim is available to secure the tag in the proper position. Place the tag shim so that the inner corner of the "L" shape fits around the bottom right corner of the tag.

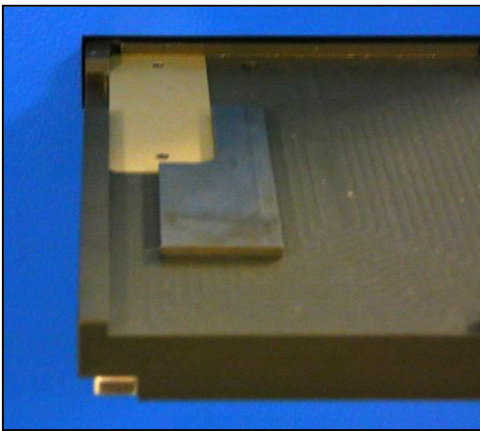

Left: A small single tag is loaded into the tag drawer. Notice the top left corner of the tag is aligned with the top left corner of the drawer. Also notice the "L" shaped tag shim aligned with the bottom right corner of the tag.

Loading Multiple Tags

1. Place desired tags into the multi-slot plate fixture for smaller die cut tags. Note: plates for several standard die-cut sizes are available, and custom plates for new sizes or combinations of sizes can be designed upon request.
2. Ensure the Tag Drawer is open.
3. Place the Plate Fixture into the Tag Drawer. The engraved ITM number should be positioned at the outside edge of the drawer.



Left: This is an example of a multi-slot plate fixture for loading several small tags.

PRINTING A TAG

Note - The following assumes the JM410 ID Tag Printer has already been setup with a tag layout. For more information on setting up a tag layout, refer to the LabeLase® Producer™ Software Manual.

There are several ways to print a tag using the JM410 ID Tag Printer.

1. Load tag(s) according to the directions above.
2. One of the following actions will initiate printing:
 - a. Pressing the **PRINT button** on the tethered remote control.
 - b. Pressing the **F12 key** on your PC.
 - c. Placing the mouse pointer over the **Begin Print** button on your PC and left clicking.
 - d. A **print command** may be sent from your host computer to your PC via Extended Protocol.
3. The drawer will begin to close as printing starts, and will continue to move in small incremental steps as each line is printed.
4. When printing is complete, the drawer will automatically return to the fully open position.
5. Once the drawer has stopped moving, remove tag(s) and reload if desired.

Note: the inside left corner of the drawer is the origin (x=0, y=0) for Producer™ tag layouts, and the arrow indicates the inward motion of the drawer during printing. When using a plate, the printable area of a tag will generally not start at the origin.



STORING THE JM410

1. When not in use, the drawer should be pushed inside the JM410 ID Tag Printer. This will prevent dust from accumulating in the drawer as well as reduce the risk of personal injury associated with the drawer protruding into the work area.
2. Engage the E-Stop by pressing in the red button to prevent the JM410 ID Tag Printer from operating unexpectedly. Gently push the drawer by hand.
3. The status line on the bottom of the Producer™ screen will display E-STOP and IDLE.
4. When you are ready to print more tags, disengage the E-Stop by twisting the red button one-quarter turn clockwise to return the JM410 to normal service. The drawer will automatically return to the full open position.

LABELASE® PRODUCER™ SOFTWARE

Labelase® Producer™ is an integrated, Windows-based application for complete control of tag design and printing. For complete details, please refer to the ONLINE REFERENCE MANUAL supplied with the software, or on the web at www.infosight.com/labelaseproducer2/.

Features:

The software has many features designed to provide maximum flexibility to serve the customer's specific marking needs. Some of these features include:

- ❑ Built-in and online (web access) HELP.
- ❑ Total freedom to change tag layout whenever needed.
- ❑ WYSIWYG (“What You See Is What You Get”) user interface for simple and intuitive tag design.
- ❑ New features emulating popular presentation software packages to speed layout and organization of complex designs containing multiple text and graphics fields.
- ❑ An unlimited number of data, text, barcode and graphics fields.
- ❑ Move fields easily with drag-and-drop.
- ❑ Rotate fields in 90-degree increments.
- ❑ Unlimited UNDO-REDO to easily correct mistakes.
- ❑ Optional placement grid with snap-to placement aid.
- ❑ Optional field anchor display shows field alignment.
- ❑ Zoom in/out for detailed display.
- ❑ Tag geometry features such as holes, slots, bare edges and bend lines can be shown.
- ❑ Prints all PC-installed fonts, including Unicode characters for all languages.
- ❑ User-selectable download of message data from a host computer via RS-232, network TCP/IP, or network file transfer. A wide selection of communications protocols includes InfoSight Extended, emulation of Zebra and Intermec standard printers, and simple comma or tab-separated, flat-file formats. Details can be found in the communications chapter of the online reference manual.
- ❑ Operator entry of message data, for example if the host computer is unavailable.
- ❑ Easy control over printer setup parameters such as laser speed (i.e., formerly known as the “heat” setting for different types of laser tag material) and high/low pixel density (i.e., “draft” and “normal” printing modes)
- ❑ UID Wizard
- ❑ GS1 Wizard
- ❑ Option to lock fields, such as background features, so they cannot be selected, moved, or edited.
- ❑ Windows Service version of Producer™ for operating in the background without the Graphical User Interface.

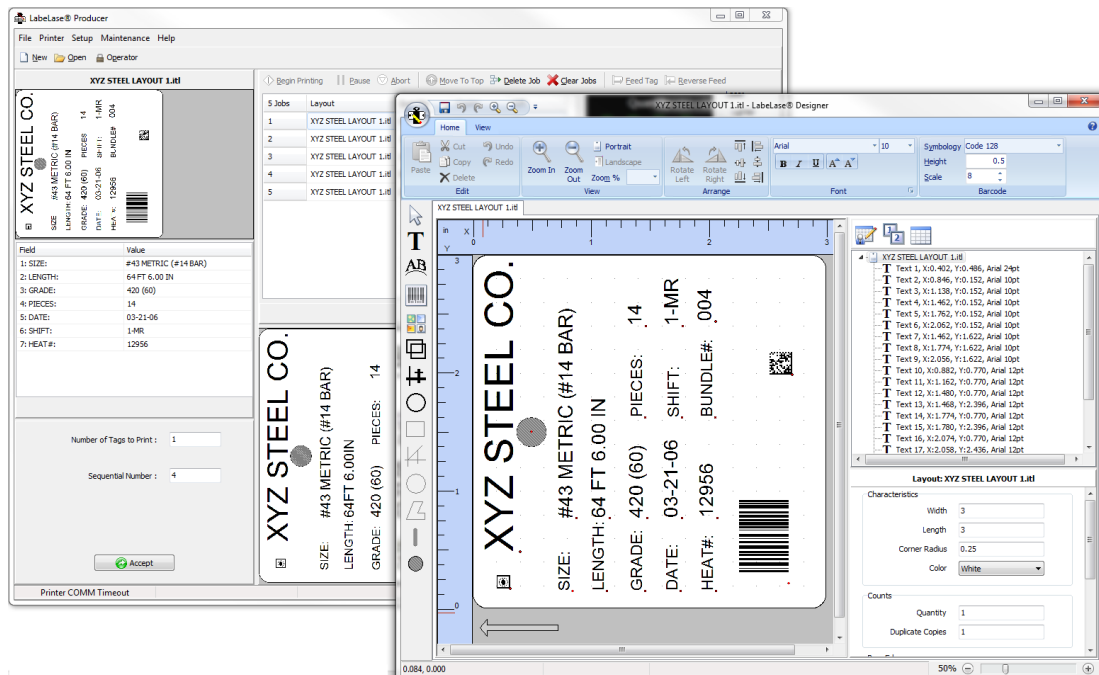

PRINTER CONFIGURATION & LASER SETTINGS

The JM410 ID Tag Printer and LabelLase® Producer™ software are designed with a high degree of flexibility and user-control, to enable the system to be used in a wide range of applications and on an ever-increasing array of laser-markable materials.

Calibration and configuration settings are accessed in LabelLase® Producer™ under SETUP-PRINTER CONFIGURATION. On-line help instructions will guide you through each of the available settings. The most common parameters for fine-tuning the performance of the printer beyond the easy-to-use LIGHTER/DARKER SLIDER BAR are LASER SPEED, LASER OFF TICKLE, and LASER ON DUTY CYCLE, all of which are found under the LASER tab. Each of these parameters separately and together can be adjusted to create the right balance of black/white contrast, fineness of detail and cycle time.

As laser speed is increased printing cycle time will be faster. In general, as laser speed increases, duty cycle must also be increased to achieve the same relative blackness. Some materials with especially sensitive surfaces, such as PermaLabel®, will print more consistently at lower duty cycles, and therefore correspondingly lower laser speeds. Tickle controls the readiness of the laser to fire and helps maintain consistency of marking across the tag surface. Some tag materials are more sensitive to power variation than others, but **in most cases this parameter can be left at its factory setting.**

Typical Range of Settings (DRAFT mode OFF):

- Laser Speed: 50-65 ips
- Laser Off Tickle: 7-15 μ s
- Laser On Duty Cycle: 85-95%

Each printer is calibrated in our factory before shipping, and the results are recorded. Save this tag in the event you ever want to return the printer to its original factory configuration.

Experience has shown the following settings to be a good starting point for the most common types of tag material. Each individual application may then be fine tuned to achieve the right balance of cycle time, fineness of detail, and black/white contrast.



Calibration Tag

Typical Laser Settings (DRAFT mode OFF)

	InfoTag® High Temp	Pic- Anneal®	PermaLabel®
Laser Speed	70	60	50
Tickle	15	15	15
Duty Cycle	95%	95%	95%

CYCLE TIME CONSIDERATIONS

Tag layout and printer configuration can have a significant influence on cycle time. Here are a few techniques that in many cases can significantly speed printing.

1. Select DRAFT mode. When DRAFT mode is on, stepper and mirror resolution, laser speed, font sizes, and barcode and graphic scales are automatically adjusted.
2. Increase laser speed (move slider bar to LIGHTER). It may be necessary to increase Laser Duty Cycle to maintain black/white contrast.

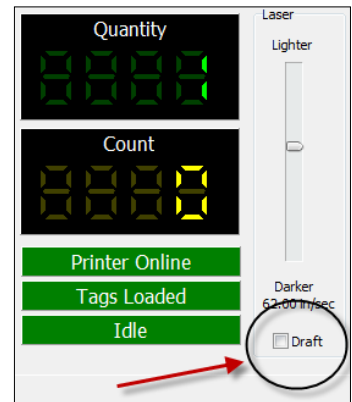

3. Use ARIAL BLACK font for text, to create darker easier-to-read characters. Also try using the BOLD font setting instead of a larger font size.

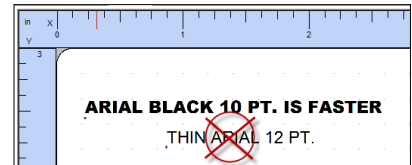

4. Design printing to run ACROSS the tag at 90° rotation (right angles to tag feed) rather than down the tag at 0° rotation (printing parallel to tag feed is slower).
5. Avoid drawing graphic boxes around text or other graphics with long vertical (parallel to tag feed) lines.

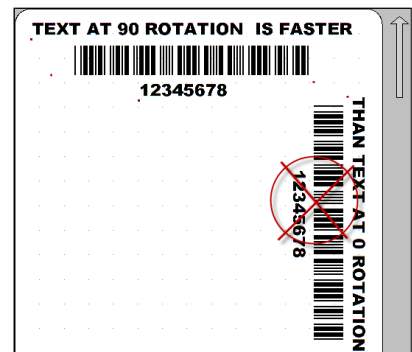

6. Combine text strings into fewer lines. A single long line of text is more efficient than several short lines of text (at 90° rotation, parallel to tag feed).

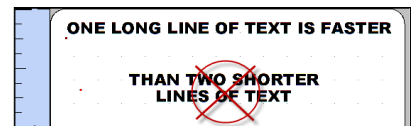

7. Keep graphics/logo X-scale and Y-scale factors equal to 1. If the graphic or logo must be re-sized to fit on the tag, use an external application such as MS PAINT to change the dimensions of the image and re-save the BMP file before importing into Producer™.

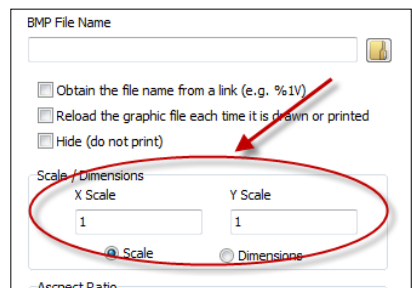

USING AN EXHAUST EXTRACTOR

The JM410 ID Tag Printer includes an optional coupling port for an exhaust extractor, located on the back of the printer.

Certain printing situations call for removing any exhaust fumes from the printing area. These situations include:

- printing on materials that create objectionable fumes
- printing on materials that create hazardous fumes
- printing large quantities of metal tags in enclosed environments

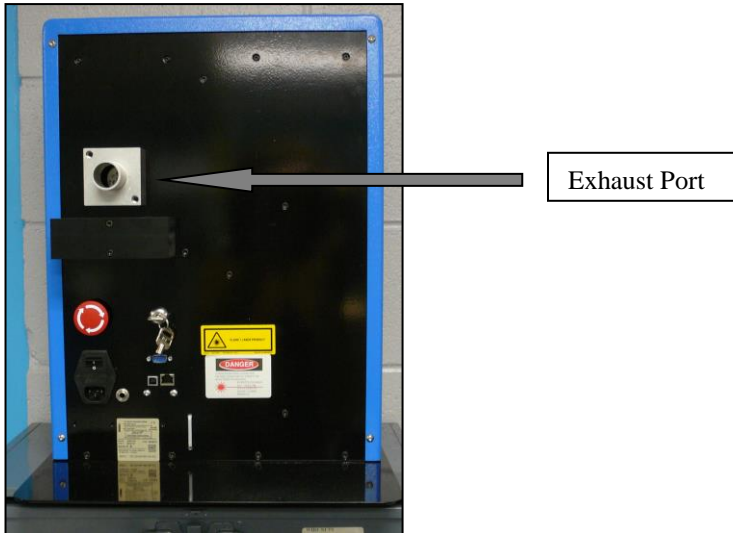

Note:

When printing large quantities of metal tags in an enclosed area or printing materials that cause objectionable or hazardous fumes, an exhaust extractor should be used to remove these fumes from the printing area.

BASIC TROUBLE SHOOTING

Service during normal business hours (Monday-Friday, 8am-5pm):

1.888.642.3600 (outside the USA call +1.740.642.3600)

Emergency after-hours service:

1.800.401.0716 (outside the USA call +1.740.642.4666)

Problem: Marker does not respond to a print command.

- Check power cord.
- Check key switch.
- Check E-STOP.
- Check Comms cable to PC.
- Producer™ software must be running on the connected PC.
- Main Producer™ screen indicates printer status – “ONLINE”, “ESTOP” or “UNKNOWN MODE”. If UNKNOWN MODE, check communications cable and settings.
- From within Producer™, click on HELP-ABOUT. If the FIRMWARE VERSION is blank or reads “?.??”, your PC does not see the printer. Check communications cable and settings (SETUP-PREFERENCES-TAG PRINTER COMMUNICATIONS).

Problem: Tag print appears very light, fine lines appear to drop out.

- Reduce laser speed (DARKER)
- Increase Laser Off Tickle (SETUP-PRINTER CONFIGURATION).
- Lens or mirror may require cleaning (see Maintenance section below).

Problem: Tag print shows “shadows”

- Decrease Laser Off Tickle (SETUP-PRINTER CONFIGURATION).

Problem: Barcode too long for tag size.

- Reduce number of characters in barcode data, especially unnecessary punctuation marks.
- Use more efficient barcode symbology, such as code 128 for all numerics (instead of code 39, for example).
- Reduce barcode scale.

NORMAL MAINTENANCE & SERVICING

The only regular maintenance required is periodic cleaning of both surfaces of the final lens and Galvanometer mirror. Please refer to the JM410 Service Manual for lens cleaning instructions.

The incoming AC line is fused on both legs. Changing fuses is not a preventive item; it only needs to be done if they are blown.

LENS CLEANING PROCEDURE

CAUTION: LASER OPTICS ALIGNMENT SHOULD ONLY BE PERFORMED BY A QUALIFIED TECHNICIAN.

ALWAYS BE SURE POWER IS OFF BEFORE OPENING THE CASE.

To reach the lenses in order to clean them:

1. Remove the outer case of the JM410 by removing the four (4) bolts in the rear of the case.

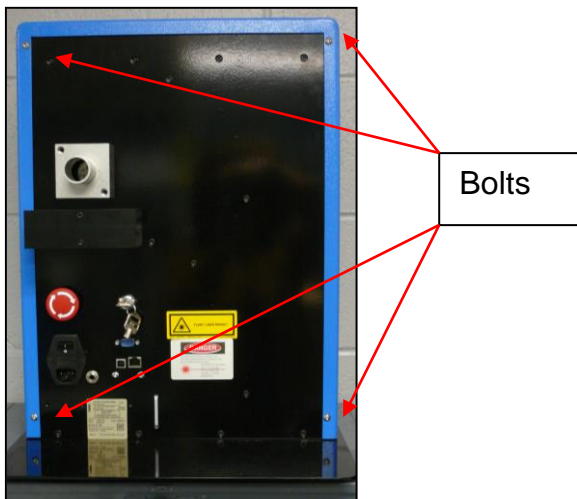

2. Ensure the drawer is pushed completely into the printer. Slide the case off of the printer by lifting straight up.



3. Clean both mirrors and both sides of all three lenses by following the procedure below.

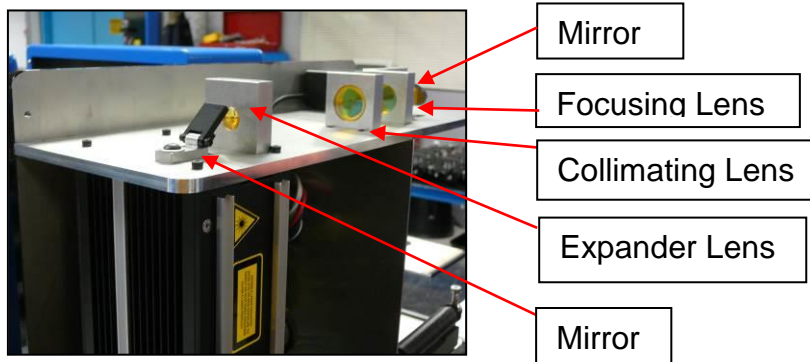

4. Slide the case back on and secure the bolts when finished.

Cleaning the lenses:

CAUTION: DO NOT TOUCH LENS WITH FINGERS OR ANY SUBSTANCE CONTAINING ALCOHOL, OR PERMANENT DAMAGE MAY RESULT.

DO NOT ATTEMPT TO ROTATE EITHER MIRROR, OR PERMANENT DAMAGE MAY RESULT

- Use a cloth or Q-Tip that will not leave any fibers and is not abrasive.
- White vinegar is recommended. DO NOT USE ALCOHOL!!
- Gently wipe the moistened cloth across the lens so that the liquid evaporates behind the cloth, avoiding streaks.
- DO NOT RUB HARD!
- DO NOT USE COMPRESSED AIR TO CLEAN OPTICS!
- DO NOT USE EYE GLASS WIPES CONTAINING ALCOHOL!
- For optics that are severely contaminated or damaged, contact InfoSight for replacement.

FUSE REPLACEMENT

The incoming AC line is fused on both legs. Before replacing the fuses, first determine and fix the cause of the blown fuses.

CAUTION: BE SURE TO REMOVE THE AC POWER CORD BEFORE REMOVING THE FUSE HOLDER OR PERFORMING ANY OTHER TROUBLESHOOTING OR MAINTENANCE!

To replace the fuses, remove the fuse holder on the back of the printer between the power cord input and the on-off rocker switch. The fuse holder only goes back in one-way. If it does not fit easily, turn it upside down and then insert it gently so that it snaps in place.



FUSE HOLDER



FUSE HOLDER REMOVED



FUSES ARE RATED FOR
250V / 5A AC Fast acting

CUSTOMER SERVICE

How to reach customer service:

Phone Support	InfoSight Corporation Customer Service offers free phone support to answer questions during normal non-holiday working hours, Monday through Friday 8am to 5pm Eastern time (New York, USA). Call +1.1.888.642.3600, or outside the USA call +1.740.642.3600.
Emergency Service	After regular business hours, call: +1.800.401.0716 (USA or Canada) or +1.740.642.4666 (International).
On-Site Service	InfoSight Corporation can dispatch a Field Service Engineer to your facility to perform equipment start-up, repair, maintenance, and training.
Service Contracts	Periodic scheduled on-site maintenance, technical service and extended warranties can be arranged by contacting Customer Service at the number below.
Factory Service	Call Customer Service for a Return Authorization Number before returning equipment to our factory for repair and/or major maintenance.

For more information regarding any of these services, call +1.888.642.3600 (outside the USA call +1.740.642.3600) and ask for Customer Service.

Or, visit us on the worldwide web at www.infosight.com

FUNCTIONAL BLOCK DIAGRAM

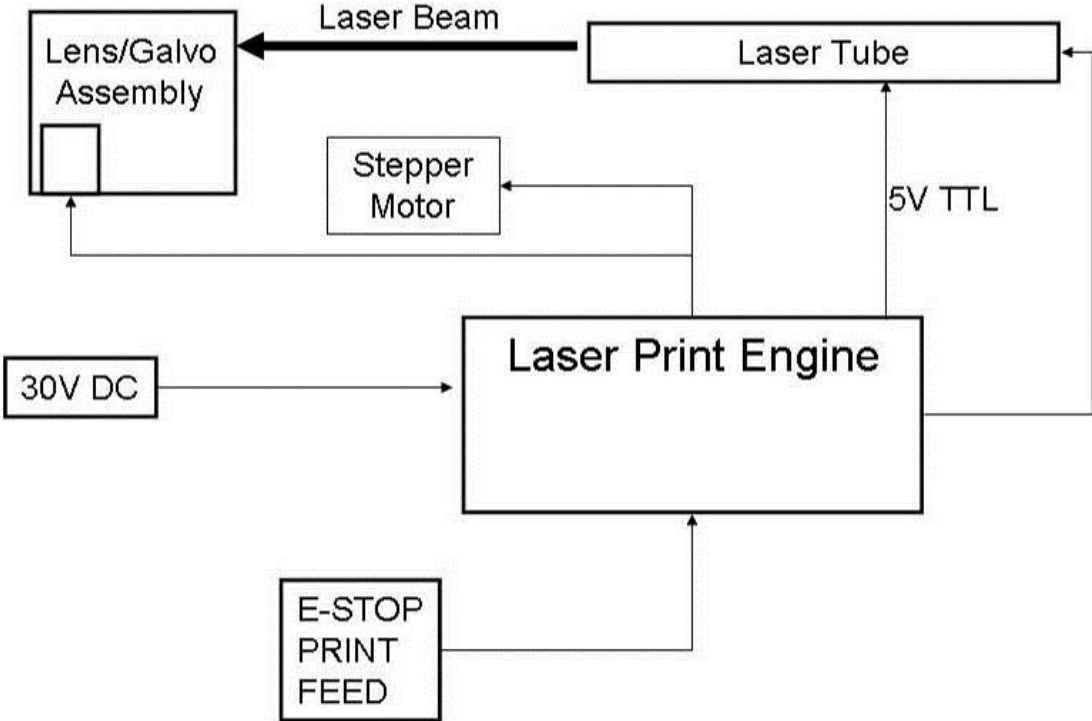

WIRING DIAGRAM

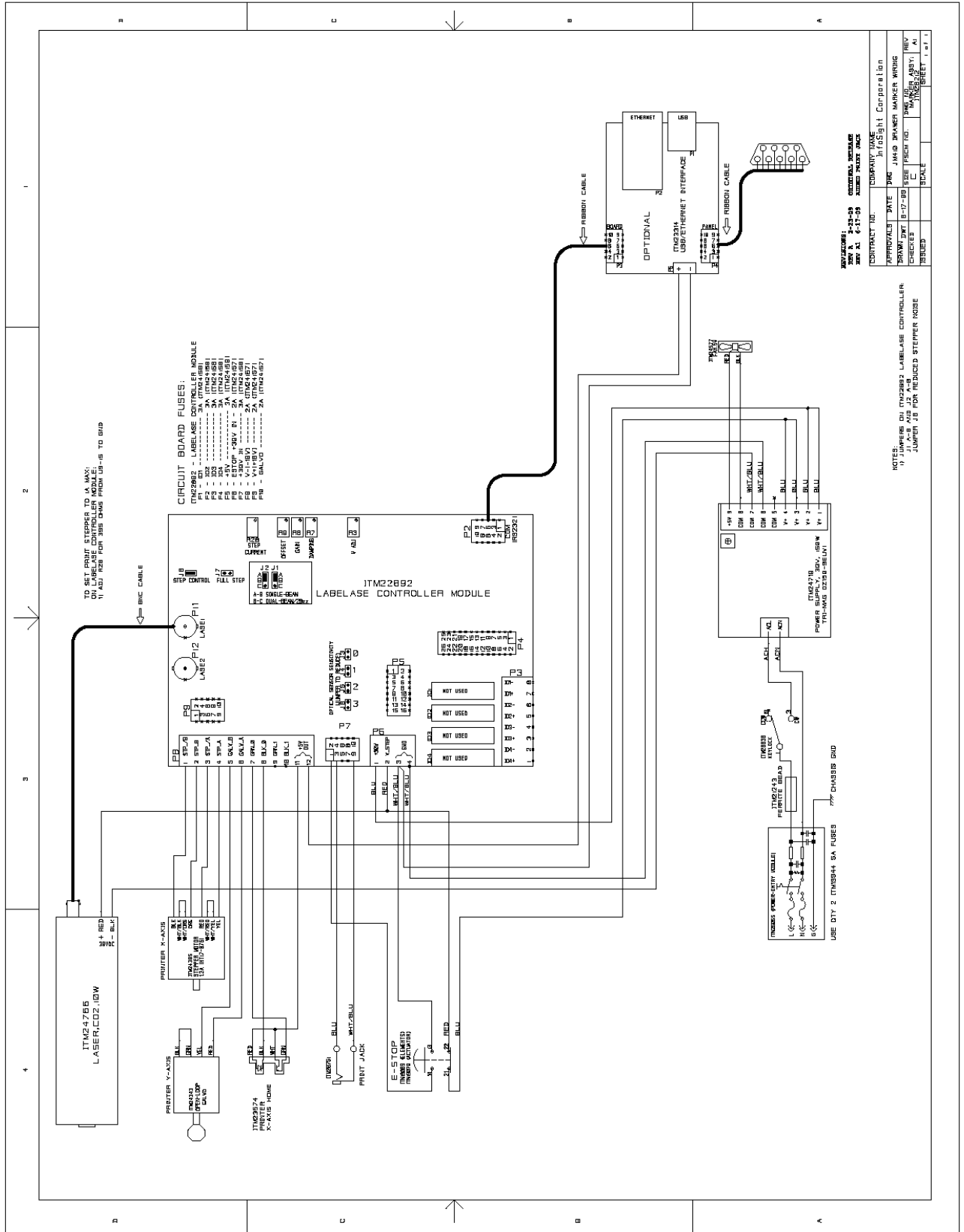

JM410 Serial port connection to an IBM-PC or equivalent.

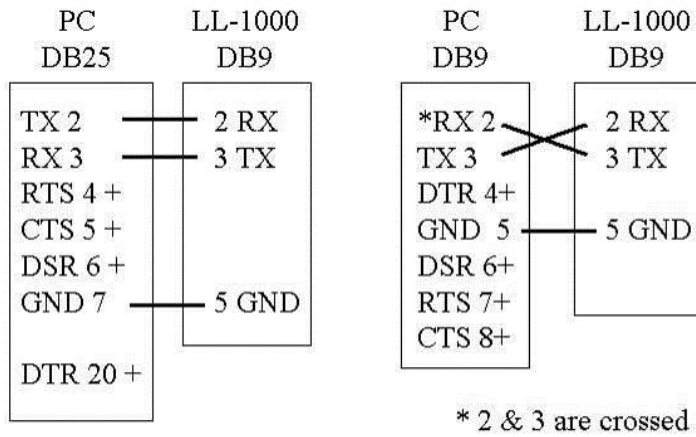

Note: Handshake protocol is XON / XOFF. Communications adapters such as USB to RS232 must support XON / XOFF.

XON is DC1 CTL-Q or 11h or 17 decimal
 XOFF is DC3 CTL-S or 13h or 19 decimal

LASER SAFETY

04/23/03

Section I: Introduction to Laser Safety

Lasers, like arc welders, are sources of intense light that require certain precautions to insure a safe, comfortable and compliant working environment. This is especially true since the laser included in this marking equipment operates in the infrared (invisible) portion of the light spectrum. The enclosure surrounding the marking area is designed to prevent human exposure to the light emitted by the laser. The following information covers the procedures taken to design a safe, efficient environment for laser marking equipment.

Laser products are categorized into one of four classes based upon the power of the laser light that is accessible to any person during normal operation. These classes range from Class 1, the lowest class requiring no additional safeguards other than those provided by the manufacturer, to Class 4, the highest class that requires additional operator and working environment safeguards for safe operation.

Class 1 laser marking systems include enclosures integral to the workstation that are constructed to prevent human access to the laser beam. Class 1 systems are safe in all working environments; they are installed and operated as any other industrial machine tool. Class 1 laser systems do not require the use of any special laser safety equipment by operators or bystanders during their normal operation.

Class 4 laser marking systems do not incorporate protective enclosures. Extra precautions are required. Avoid eye or skin exposure to direct or scattered radiation.

The JM410 ID Tag Printer complies with Class 1 during normal use because of the numerous interlocks provided as detailed in section II.

During service and/or alignment the JM410 ID Tag Printer becomes a Class 4 device. Servicing should be performed only by a **Qualified Laser Service/Safety Technician!** Because of the Class 4 classification, InfoSight will provide such a person to be available to the end user of this marker.

The nominal power output of the laser used is 10 watts, with a maximum peak power output of 30 watts. It is a CO₂ infrared (invisible) laser with a wavelength of 10.57 to 10.63 microns. The Radiant energy and the wavelength are less than Class 1 requirements during normal operation.

Section II: Types of safety interlocks.

There are several types of safety features provided on the InfoSight JM410 ID Tag Printer:

Type 1 includes **Mechanical Switches**. These switches are located atop the printer and on the rear of the printer. These switches remove power supplied to the laser printer, as shown in electrical drawings.

- Switch A -- Large Red, easily accessible, E-STOP operator Emergency Stop Push Button.
- Switch B -- Key switch
- Switch C -- On/Off rocker switch

Type 2 includes **Optical Sensors**. Sensors monitor whether tag material is in place and the printer is able to move the tag material. These two sensors are monitored by the marking microprocessor.

Type 3 includes **Mechanical Design**. Here, narrow slots are provided to minimize the release of laser radiation. The beam path from laser tube to final pass through lens is entirely enclosed in a metal shield, with suitable material that will absorb the heat produced by the beam emitting from the CO₂ laser.

Type 4 includes **Password Security Access**. The Software requires a **Supervisor Password** to change layout of tags or to alter the operating parameters of the printer itself.

The features and precautions described above are designed with the safety of the user in mind. Should you have any questions or suggestions please contact InfoSight directly.

DECLARATION OF CONFORMITY

InfoSight Corporation

20700 US Highway 23 Chillicothe, Ohio 45601
(740) 642-3600 TEL (740) 642-5001 FAX

InfoSight hereby declares the equipment specified conforms to the Classification(s), Directive(s) and Standard(s) set forth in this document.

InfoSight produces laser systems within one of two classes as identified and classified by the CDRH. These are Class I and Class IV. (See CDRH 21 CFR (J) 1040.1 - 1040.5). End user of the equipment should be familiar with ANSI, CDRH and OSHA standards for radiation emitting devices as they apply to them also.

ANSI Z136.1 - 1993

During servicing we will provide adequate data to the LSO (Laser Safety Officer) enabling LSO to designate NHZ (nominal hazard zone) as required pursuant to Class IV 3.4.1

CDRH 21 CFR (J) 1040.1 1040.5

OSHA Publication 8-1.7 Section II Chapter 6

Certifications:

EMC

IEC 61000-6-2:2005, IEC 61000-6-4:2006, IEC 61000-3-2:2005 w/ A1:2008 and A2:2009,
IEC 61000-3-3:2008 & CFR47 FCC Part 15, Subpart B:2009

Name and Publication Date of Standard Used to Evaluate Laser safety:

IEC EN 61010-1:2001
IEC 60825-1: 2007 (2nd Edition)

Note: InfoSight design guidelines are drawn from ANSI and CDRH



1.1.1 JM410 Declaration of Conformity

Declaration of conformity

Konformitätserklärung

Déclaration de conformité

Declaración de Confomidad

Verklaring de overeenstemming

Dichiarazione di conformità

We/Wir/ Nous/WIJ/Noi: **InfoSight Corporation**

20700 US Highway 23

Chillicothe, Ohio 45601 USA

declare under our sole responsibility that the product,
erklären, in alleniniger Verantwortung, daß dieses Produkt,
déclarons sous notre seule responsabilité que le produit,
declaramos, bajo nuestra sola responsabilidad, que el producto,
verklaren onder onze verantwoordelijkheid, dat het product,
dichiariamo sotto nostra unica responsabilità, che il prodotto,

JM410

to which this declaration relates is in conformity with the following standard(s) or other normative documents.
auf das sich diese Erklärung bezieht, mit der/den folgenden Norm(en) oder Richtlinie(n) übereinstimmt.
auquel se réfère cette déclaration est conforme à la (aux) norme(s) ou au(x) document(s) normatif(s).
al que se refiere esta declaración es conforme a la(s) norma(s) u otro(s) documento(s) normativo(s).
waarnaar deze verklaring verwijst, aan de volende norm(en) of richtlijn(en) beantwoordt.
a cui si riferisce questa dichiarazione è conforme alla/e seguente/i norma/o documento/i normativo/i.

EMC

**IEC 61000-6-2:2005, IEC 61000-6-4:2006, IEC 61000-3-2:2005 w/ A1:2008 and A2:2009,
IEC 61000-3-3:2008 & CFR47 FCC Part 15, Subpart B:2009**

Safety

IEC EN 61010-1:2001

IEC 60825-1 : 2007 (2nd Edition)

Edward S. O'Neal

8/2009

Chillicothe, Ohio

APPENDIX A | LASER SAFETY

Laser Hazard Classifications

The intent of laser hazard classification is to provide clear distinction of the lasers' properties and hazards to users so appropriate protective measures can be taken. Classification is based on the maximum output available for the intended use. Specific labeling requirements indicate that the class of the laser as well as the emission wavelength(s) and any other applicable precautionary instructions must be included on any signage. Laser classification is also used for determining requirements for medical surveillance for those individuals working with and around lasers.

The Federal United States laser safety standard [21 CFR 1040.10], the ANSI standard [ANSI Z136.1], as well as the international standard [EN 60825], divide lasers into five distinct hazard categories. These classes are based upon the combination of wavelength range, power, and emission duration, which are used to determine the level of risk and the potential to cause biological damage to the eye or skin. The definitions compiled from ANSI Z136.1 are as follows:

Class 1: Any laser, or laser system containing a laser, with wavelength ranges from Ultraviolet through Far Infrared (180 nm – 100,000 nm +), that cannot emit laser radiation levels exceeding Class 1 Accessible Emission Limits (AEL) as defined by ANSI Z136.1. For example this would compute to exposure (for an eight-hour period) for a 488 nm laser of no greater than 0.2 mW. Basically, the laser radiation level emitted by a device classified as Class 1 produces no hazard whatsoever to the user during normal operation. Presently, Class 1 lasers and laser systems are exempt from all control measures. The Class 1 designation does not apply during times of maintenance or service where the safety controls of the device are defeated or otherwise removed. The Class 1 environment resumes once the device is returned to its original state with all safety devices properly reconnected.

Class 2: This classification applies only to continuous wave (CW) and repetitive-pulse lasers and laser systems of the visible part of the electromagnetic spectrum (400 – 700 nm) that exceed Class 1 levels, but do not exceed an average radiant power of 1 mW.

Class 3a: Lasers and laser systems that have an accessible output between one and five times the Class 1 AEL for wavelengths shorter than 400 nm or longer than 700 nm, or less than five times the Class 2 AEL for wavelengths between 400 and 700 nm. Lasers of this class have intermediate power ranges of 1 - 5 mW.

Class 3b: Lasers and laser systems having the power range between 5 - 500 mW. This applies to lasers with wavelength ranges from Ultraviolet through Far Infrared (180 nm – 100,000 nm +). These lasers or laser systems can produce a hazard if viewed directly, and may produce an eye hazard when viewing diffuse reflections off of a shiny surface at angles of less than 5 degrees from the source, however Class 3b lasers should not produce a hazardous diffuse reflection from a matte (not shiny) surface.

Class 4: Lasers and laser systems having power greater than 500 mW. This applies to lasers with wavelength ranges from Ultraviolet through Far Infrared (180 nm – 100,000 nm +). This class of laser poses the greatest hazard, and any and all precautions should be taken to protect oneself from exposure to direct or diffuse laser radiation. Direct exposure to the eye from this class of laser can cause permanent damage. Stray beams are potential fire hazards and combustible material should be kept out of beam paths at all times.

1.2 CONTROL MEASURES FOR LASER CLASSIFICATIONS

Control Measure	Class 1	Class 2	Class 3a	Class 3b	Class 4
Activation Warning Systems	No requirement.	No requirement.	No requirement.	Should have.	Shall have.
Indoor Laser XE Optics Lasers Controlled Area	No requirement.	No requirement.	No requirement.	Shall have. Nominal Hazard Zone analysis required.	Shall have. Nominal Hazard Zone analysis required.
Labels	Shall have	Shall have	Shall have.	Shall have.	Shall have.
Area Posting	No requirement.	No requirement.	Should have	Shall have. Nominal Hazard Zone analysis required.	Shall have. Nominal Hazard Zone analysis required.
Standard Operating Procedures	No requirement.	No requirement.	No requirement.	Should have.	Shall have.
Education and Training	No requirement.	Should have.	Should have.	Shall have.	Shall have.
Authorized Personnel	No requirement.	No requirement.	No requirement.	Shall have.	Shall have.
Warning Signs and Labels	No requirement	Should have.	Should have.	Shall have. Nominal Hazard Zone analysis required.	Shall have. Nominal Hazard Zone analysis required.

ANSI Z136.1 requires specific control measures for each laser classification and the environment in which they are used. The chart above lists some of the requirements that may need to be implemented in a laboratory setting. The company Laser Safety Officer, or designee, should reference the applicable safety regulations for appropriate control measures to implement in the area the marker will be used.

1.3 BIOLOGICAL EFFECTS OF LASER IRRADIATION

1.3.1 Eye Injury

Because of the high degree of beam collimation, a laser serves as an almost ideal point source of intense light. A laser beam of sufficient power can theoretically produce retinal intensities at magnitudes that are greater than conventional light sources, and even larger than those produced when directly viewing the sun. Eye exposure to a direct beam can cause permanent eye damage including blindness. Protective eyewear should always be worn when potential exposure to direct laser beams exist.

- Due to the lens-like focusing effect of the human eye, it is 100,000 times more vulnerable to injury than the skin.
- Laser safety eyewear should always be available for the wavelengths of lasers in use.
- Eye protective equipment, however, should be considered the last line of defense against laser beam exposure – engineering and administrative controls should be used first.
- Remove all jewelry when working with an open beam to prevent reflection of the beam in unsafe directions.
- When possible, use all protective housings, interlocks and shields.
- Laser Safety Eyewear should always be worn during laser repair, alignment, or installation, or at any time when any laser safety control is not in place.

1.3.2 Thermal Injury

The most common cause of laser-induced tissue damage is thermal in nature, where the tissue proteins are denatured due to the temperature rise following absorption of laser energy.

The thermal damage process (resulting in burns) is generally associated with lasers operating at exposure times greater than 10 microseconds and in the wavelength region from the near ultraviolet to the far infrared. Tissue damage may also be caused by thermally induced acoustic waves following exposures to sub-microsecond laser exposures.

1.3.3 Skin Injury

To the skin, UVA (315-400 nm) can cause hyperpigmentation and erythema (aka: sunburn). Exposure in the UVB (280-315 nm) range is most injurious to skin. In addition to thermal injury caused by ultraviolet energy, there is also possibility of radiation carcinogenesis from UVB. The shorter wavelengths are absorbed in the outer dead layers of the epidermis (stratum corneum) and the longer wavelengths have an initial pigment-darkening effect followed by erythema if there is exposure to excessive levels.

The hazards associated with skin exposure are of less importance than eye hazards; however, with the expanding use of higher-power laser systems, particularly ultraviolet lasers, the unprotected skin of personnel may be exposed to extremely hazardous levels of the beam power if used in an unenclosed system design.

Skin burns caused by lasers can happen quite fast and with great intensity. Protective clothing should be worn when potential exposure to direct laser beams exist.

- UVC: 200-280 nm exposure may cause erythema (sunburn), skin cancer, and burns.
- UVB: 280-315 nm exposure may cause accelerated skin aging, increased skin pigmentation and burns.
- UVA: 315-400 nm exposure may cause pigment darkening and skin burns.
- Visible: 400-700 nm exposure may cause photosensitive reactions and skin burns.
- Infrared 700-100,000 nm exposure may cause skin burns.